

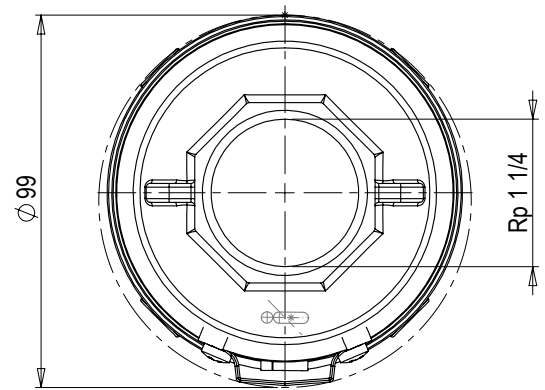

SCALA 1:2



Note: Notes:			Tolleranze non indicate: Tolerances not indicated:		
Smussi non quotati: Unlisted chamfers:	Raggi non quotati: Unlisted rays:	Sforni non quotati: Unlisted draft angles:	Finitura: Surface quality:		
Descrizione / Description: POMPA 4SDPM 4/18C			Quota di controllo: Control dimension:		
			Materiale: Material:		
			Trattamenti: Treatments:		
	Formato: Size: A4	Modello-Stampo: Model-Mold:	Peso grezzo kg: Raw weight kg:	Peso finito kg: Finish weight kg:	
	Dimensioni in mm Dimensions in mm	Dipartimento: Department: Z01	N° Disegno / Drw N°:	Vers:	Foglio / Sheet:
	Scala / Scale: 1:5	Data / Date: 26.10.2021	Disegnato / Drawn: DS00241	Approvato / Checked:	10013050
				1/1	